

HERZ - Filter for potable water

Data sheet 2 3010 0X, Issue 1119

☑ Dimensions

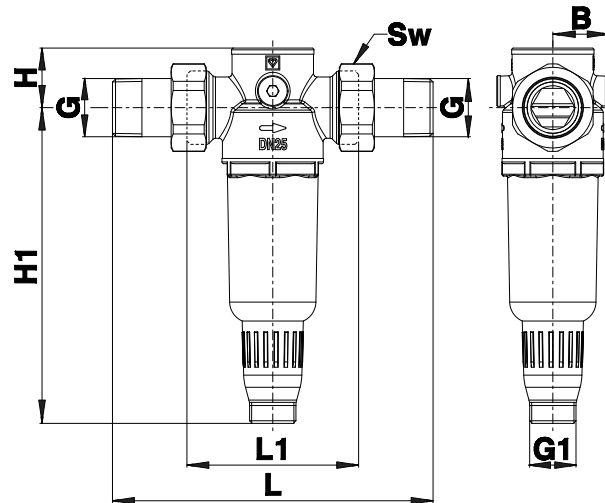

Model	DN	PN [bar]	G [in]	G1 [in]	L [mm]	L1 [mm]	B [mm]	H [mm]	H1 [mm]	Sw [mm]
2 3010 01	15	16	1/2"	3/4"	147	84	32	34	180	30
2 3010 02	20	16	3/4"	3/4"	155	84	32	34	180	37
2 3010 03	25	16	1"	3/4"	185	98	32	34	180	46

☑ Construction

Body:	forged brass acc. to EN 12165; CW626N
Sealing in drain valve:	EPDM
Filter mesh:	stainless steel
Bottom cover:	PA12, transparent (GRILAMID TR90)
Drain valve:	PA6 + 30GF
Mesh holder:	POM (HOSTAFORM C9021)

☑ Specifications

Mesh perforatio:	80 - 100 µm
Medium:	potable water
Maximum inlet pressure:	16 bar
Maximum temperature:	40°C
Standard:	EN 13443-1
Pressure gauge connectors:	1/4" F (ISO 228-1)
Connectors:	external thread acc. to ISO 7-1 and ISO228

☑ Nominal flow rates

Size	DN 15	DN 20	DN 25
Flow rate at $\Delta p=0,2$ bar (m ³ /h)	1,13	1,80	2,76
Flow rate at $\Delta p=0,5$ bar (m ³ /h)	2,19	3,80	5,65
Flow rate at $\Delta p=1$ bar (m ³ /h)	3	4,94	7,22



☑ Assembly

Before assembling rinse the system well. In potable water installations the filter should be mounted directly behind the water meter. Install the filter in a horizontal position with the filter facing down. Take care of the flow direction, indicated on the housing. Proper operation requires a straight piece of at least 5x DN pipe before and after the filter. Before and after the filter, it is necessary to install a closing valve. Filter must be installed without any mechanical tensions in the pipeline, leaving enough space for maintenance.

☑ Application and maintenance

Filter for potable water ensure a continuous supply of filtered water. Filter prevents the entry of impurities such as rust particles, grains of sand and other impurities. The filter should be backwashed every 6 months or as needed. To backwash the filter open and close the green drain valve of 2-3 times. The drain valve also has an external thread G3/4" on which we can screw the pipe fitting and clean the filter through the hose. A continuous supply of filtered water is available also during the back backwash cycle. If the filter is in a bad condition it can be replaced it with a new one. Tool for maintenance is included in every box of filter for potable water.

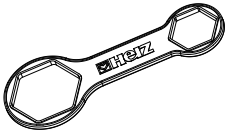
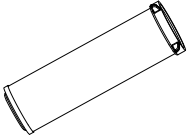
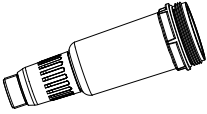
☑ Spare parts:

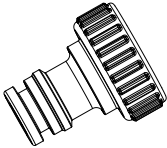
Illustration	Description	Item number
	Tool for maintenance	1 2682 27
	Filter	2 6301 00
	Cover with drain valve	2 6301 01
	Manometer	1 2682 34
	Hose connection	1 6206 02

Pressure drop diagram

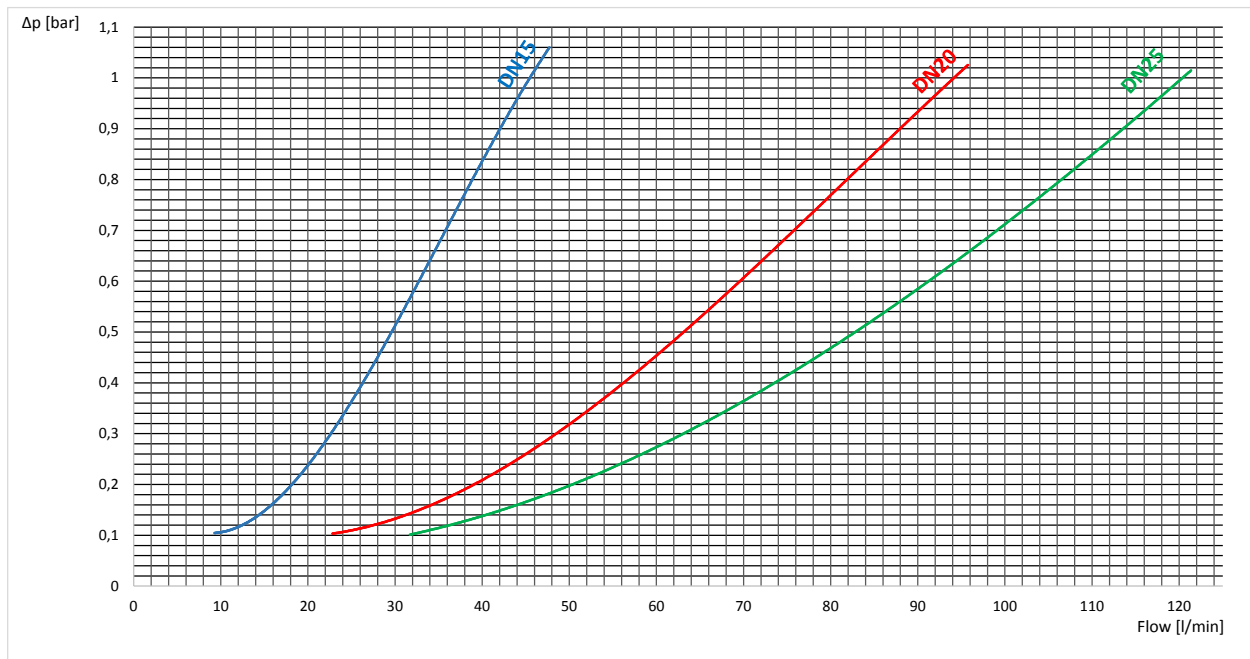

Disposal instruction

The disposal of HERZ-filter for potable water stem extension must not endanger the health or the environment. National legal regulations for proper disposal of the HERZ-filter for potable water stem extension have to be followed.

Material

Pursuant to Article 33 of the REACH Regulation (EC No. 1907/2006), we are obliged to point out that the material lead is listed on the SVHC list and that all brass components manufactured in our products exceed 0.1 % (w / w) lead (CAS: 7439-92-1 / EINECS: 231-100-4). Since lead is a component part of an alloy, actual exposure is not possible and therefore no additional information on safe use is necessary.

Please note: All specifications and information within this document are reflecting the information available at the time of going to print and meant for informational purpose only. Herz Armaturen reserves the right to modify and change products as well as its technical specifications and/or its function according to technological progress and requirements. All diagrams are indicative in nature and do not to be complete. It is understood that all images of Herz products are symbolic representations and therefore may visually differ from the actual product. Colours may differ due to printing technology used. In case of any further questions don't hesitate to contact your closest HERZ Branch-Office.

Example of system with HERZ products

